

FUSION[®] MS-RA210

OWNER'S MANUAL



ENGLISH

FUSION[®]
A Garmin Brand

© 2019 Garmin Ltd. or its subsidiaries

All rights reserved. Under the copyright laws, this manual may not be copied, in whole or in part, without the written consent of Garmin. Garmin reserves the right to change or improve its products and to make changes in the content of this manual without obligation to notify any person or organization of such changes or improvements. Go to www.fusionentertainment.com for current updates and supplemental information concerning the use of this product.

Garmin®, ANT®, Fusion®, and the Fusion logo are trademarks of Garmin Ltd. or its subsidiaries, registered in the USA and other countries. Connect IQ™, Fusion-Link™, and Fusion-Link Lite™ are trademarks of Garmin Ltd. or its subsidiaries. These trademarks may not be used without the express permission of Garmin.

Apple®, iPhone®, and iPod touch® are trademarks of Apple Inc., registered in the USA and other countries. App Store™ is a service mark of Apple Inc., registered in the USA and other countries. Android™ and Google Play™ are trademarks of Google Inc. BLUETOOTH® word mark and logos are owned by the Bluetooth SIG, Inc. and any use of such marks by Garmin is under license. NMEA 2000® and the NMEA 2000 logo are registered trademarks of the National Marine Electronics Association. SiriusXM®, SportsFlash™, TuneMix™, TuneStart™, and all related marks and logos are trademarks of Sirius XM Radio Inc. All rights reserved. Other trademarks and trade names are those of their respective owners.

M/N: A03771 IC: 1792A-03771

Table of Contents

Getting Started	1	Controlling Music Playback on a Connected Apple Device	10
Stereo Controls	2	USB Source Settings	10
Entering Text	3	Radio	10
Using the Dial to Select Items	3	Setting the Tuner Region	10
Stereo Screen	4	Changing the Radio Station	11
Setting the Home Zone	4	SiriusXM Satellite Radio	11
Selecting a Source	4	Setting the Tuner Region for the SiriusXM Source	11
Adjusting the Backlight and Dial Brightness	4	Locating the SiriusXM Radio ID	11
Audio Control	5	Activating a SiriusXM Subscription	11
Adjusting the Volume	5	Selecting a Category	11
Adjusting the Subwoofer Level	5	Using Replay Mode	12
Adjusting the Tone	5	Alerts	12
Disabling the Loud Setting for a Zone	5	Adding an Artist or Song Alert	12
Adjusting the Gain for an Auxiliary Device	5	Adding Teams for Game Alerts	12
Speaker Zones	5	Adding Teams from a Live Game	12
DSP Settings	5	Viewing Active Alerts	12
Configuring the DSP Settings	6	Managing Alerts	13
Automatic Volume Adjustment Based on Speed	6	TuneMix™ Feature	13
Media Player Connection	6	Starting and Stopping a TuneMix Collection	13
Bluetooth Device Playback	7	Creating and Customizing a TuneMix Collection	13
Connecting a Compatible Bluetooth Device	7	SportsFlash Feature	14
Bluetooth Range Information	7	Adding Teams to Receive SportsFlash Alerts	14
Selecting a Different Bluetooth Device	7	Changing SportsFlash Team Priority	14
Bluetooth Source Menu and Settings	8	Enabling the TuneStart™ Feature	14
Disabling Bluetooth Auto Connection	8	Parental Controls	14
USB Device Playback	8	Unlocking the Parental Controls	15
USB Device Compatibility	9	Locking Channels	15
Connecting a USB Device	9	Clearing All Locked Channels	15
Controlling Music Playback on a USB Flash Drive or Media Player	9	Changing the Parental Control Passcode	15
Controlling Music Playback on a Connected Android Device	9	SiriusXM Troubleshooting	16
		Clearing SiriusXM Data	16
		DAB Playback	17
		Setting the Tuner Region	17
		Scanning for DAB Stations	17
		Changing DAB Stations	17

Selecting a DAB Station from a List	17
Selecting a DAB Station from a Category	17
Presets	18
Saving a Station or Channel as a Preset	18
Selecting a Preset from a List	18
Removing Presets	18
Connecting an Auxiliary Device	18
General Settings	19
Speaker Zone Settings	19
Disabling the Internal Amplifier	19
Setting the Home Zone	19
Synchronizing the Source and Zone Volume Levels	19
Adjusting the Power-On Volume Limit	20
Maintaining Individual Zone Volume Levels	20
Enabling Automatic Volume Adjustment Based on Speed	20
Automatic Volume Control Settings	20
Disabling a Zone	21
Setting a Zone Name	21
Linking Zones	21
Adjusting the Subwoofer Filter	21
Adjusting Additional Audio Settings for a Zone	22
Power Options	22
Source Settings	22
Update Options	22
Additional Stereo Control Options	23
Connecting to a Garmin® Watch	23
Connecting to an ARX70 Remote Control	23
Fusion-Link Wireless Remote Control App	23
FUSION-Link™ Network Technology	23
NMEA 2000 Remote Control and Display	24
NMEA 2000 Information	24
Appendix	24
Registering Your Fusion Device	24
Software Updates	24
Updating the Software Using a USB Flash Drive	24
Troubleshooting	25
The stereo does not respond to key presses	25
The stereo keeps locking up when connected to an Apple device	25
The stereo is not finding my connected Apple device	25
My Bluetooth audio is interrupted by short breaks	25
The stereo does not display all song information from my Bluetooth source	25
Specifications	26

Stereo Dimension Drawings 27
Side Dimensions 27
Top Dimensions 27

Index 28





Getting Started

WARNING

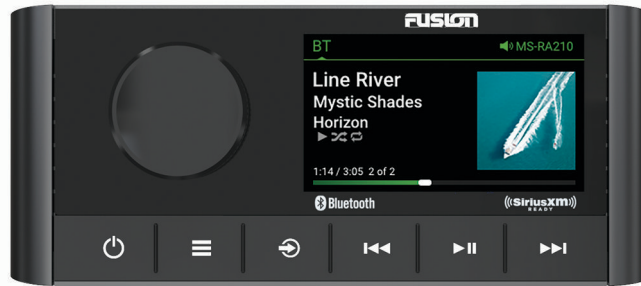
See the *Important Safety and Product Information* guide in the product box for product warnings and other important information.

Stereo Controls



Dial	<ul style="list-style-type: none"> • Turn to adjust the volume. • When adjusting the volume, press to switch between zones. • Turn to move through the menus or adjust a setting. • When in a menu, press to select the highlighted option. • Press and hold to activate certain functions such as opening the radio presets.
	<ul style="list-style-type: none"> • Press to turn on the stereo. • Press to mute the audio. • Press and hold to turn off the stereo. • Press and hold for longer than 10 seconds to reset the stereo.
	<ul style="list-style-type: none"> • Press to open the menu. • Press to return to the previous screen from the menu. • Press and hold to exit the menu.
	<p>Press to change the source.</p> <p>TIP: You can turn the dial to browse, and press the dial to select the source.</p>
	<ul style="list-style-type: none"> • Press to skip to the beginning of the track or to the previous track, when using an applicable source. • Press and hold to rewind the track, when using an applicable source. • AM/FM source: <ul style="list-style-type: none"> ◦ Press to tune to the previous station or preset. ◦ Press and hold for faster tuning (manual mode only). • AUX: Press to decrease the gain. • SiriusXM source: <ul style="list-style-type: none"> ◦ In Live Mode, press to tune to the previous station or preset. ◦ In Live Mode, press and hold for faster tuning, in Manual mode only. ◦ In Replay Mode, press to skip to the previous track. ◦ In Replay Mode, press and hold to rewind the current track. • DAB source: <ul style="list-style-type: none"> ◦ Press to return to the previous DAB station in the ensemble. When you reach the beginning of the current ensemble, the stereo automatically changes to the last available station in the previous ensemble. ◦ Press and hold to return to the previous DAB ensemble.
	<ul style="list-style-type: none"> • Press to pause or resume media playback. • AM/FM source: <ul style="list-style-type: none"> ◦ Press to cycle through the tuning modes (Auto, Manual, and Preset). ◦ Press and hold to save the selected station as a preset. • SiriusXM source: <ul style="list-style-type: none"> ◦ Press and hold to switch between Replay Mode and Live Mode. ◦ In Live Mode, press to cycle through the tuning modes (Manual, Category, and Preset).

- In Replay Mode, press to pause and play.
- DAB source:
 - Press to scan for DAB stations.
 - Press and hold to save the current station as a preset.

- Press to skip to the next track or station, when using an applicable source.
- Press and hold to fast-forward, when using an applicable source.
- AM/FM:
 - Press to tune to the next station or preset.
 - Press and hold for faster tuning (manual mode only).
- AUX: Press to increase the gain.
- SiriusXM source:



- In Live Mode, press to tune to the next station or preset.
- In Live Mode, press and hold for faster tuning, in Manual mode only.
- In Replay Mode, press to skip to the next track, if applicable.
- In Replay Mode, press and hold to fast-forward the current track, if applicable.
- DAB source:
 - Press to advance to the next DAB station in the ensemble. When you reach the end of the current ensemble, the stereo automatically changes to the first available station in the next ensemble.
 - Press and hold to advance to the next DAB ensemble.

Entering Text

- 1 In a field that allows you to enter text, select to erase the existing characters.
- 2 If necessary, select or to use numerals, symbols, or lower-case letters when available.
- 3 Turn the dial to choose a character, and press the dial to select it.
- 4 Select to save the new text.

Using the Dial to Select Items

You can use the dial to highlight and select items on the screen.

- Turn the dial to highlight an item on the screen.
- Press the dial to select the highlighted option.

Stereo Screen

The information displayed on the screen varies depending on the source selected. This example shows the device playing a track on a device connected using Bluetooth® wireless technology.



① Source name

② Active zone

③ Track details (if available)

④ Album art (if available from a compatible source)

⑤ Elapsed time, track duration, and the current track number out of the total number of tracks in the playlist (if available)

Setting the Home Zone

The home zone is the speaker zone that you adjust by default when you turn the dial.

- 1 Select  > **SETTINGS**.
- 2 Select **ZONE** > **ASSIGN HOME ZONE**.
- 3 Select a zone.

Selecting a Source

- 1 Select .
- 2 Turn the dial to highlight a source.
- 3 Press the dial to select the source.

Adjusting the Backlight and Dial Brightness

NOTE: If you connected the dim wire on the wiring harness to the boat's illumination wire, the backlight and dial dim automatically when the boat lights are on. This may affect how you adjust the brightness setting.

- 1 Select  > **BRIGHTNESS**.
- 2 Adjust the brightness level.

Audio Control

Adjusting the Volume

- 1 Turn the dial to adjust the volume for the home zone on the stereo.
- 2 If necessary, press the dial to switch between zones.

Adjusting the Subwoofer Level

You can adjust the subwoofer level for each zone.

- 1 Press the dial, and select a zone with a connected subwoofer.
- 2 Press and hold the dial.
The SUB LEVEL adjustment for the zone appears.
- 3 Adjust the subwoofer level and press the dial to set it.

Adjusting the Tone

- 1 Select  > **AUDIO**.
- 2 Select the zone to adjust.
- 3 Press the dial to select a tone.
- 4 Adjust the tone level and press the dial to set it.



Disabling the Loud Setting for a Zone

The LOUD setting maintains frequency response at low volumes and increases perceived loudness at high volumes. This setting is enabled by default in all zones.

- 1 Select  > **AUDIO**.
- 2 Select a zone to adjust.
- 3 Select **LOUD** to clear the check box.

Adjusting the Gain for an Auxiliary Device

You can adjust the gain for a connected auxiliary device to achieve a volume level similar to that of other media sources. You can adjust the gain in 1 dB increments.

- 1 Select an auxiliary source.
- 2 Select an option:
 - To increase the gain, select .
 - To decrease the gain, select .

NOTE: To achieve the best audio quality when using a portable media player with headphone output, it may be necessary to adjust the volume control on the media player, instead of adjusting the gain.

Speaker Zones

You can group speakers in one area into a speaker zone. This enables you to control the audio level of the zones individually. For example, you could make the audio quieter in the cabin and louder on deck.

You can set the balance, volume limit, tone, subwoofer frequency, and name for each zone, and configure other zone-specific settings ([Speaker Zone Settings, page 19](#)).

DSP Settings



This stereo features digital signal processing (DSP). You can select pre-configured DSP settings for Fusion® speakers and amplifiers to optimize audio reproduction in their installed locations.

All DSP settings are configured using the Fusion-Link™ remote control app ([Fusion-Link Wireless Remote Control App, page 23](#)).

Configuring the DSP Settings

You must download and install the Fusion-Link remote control app on your compatible Apple® or Android™ device before you can configure the DSP settings (*Fusion-Link Wireless Remote Control App, page 23*).

You can configure the DSP settings to optimize the sound on each zone with the installed speakers, amplifiers, and environment.

- 1 From the settings menu on your Apple or Android device, connect to the stereo using Bluetooth technology.
- 2 Open the Fusion-Link remote control app on your compatible Apple or Android device.
- 3 If necessary, select the stereo you want to configure.
- 4 Select .
- 5 If necessary, select the **MUSIC** tab.
- 6 Select a zone.
- 7 Select **DSP SETTINGS**.
- 8 Configure the DSP settings as needed, depending on the models of Fusion speakers and amplifiers connected to the zone.
- 9 Repeat these steps for each zone.
- 10 After you have finished configuring the DSP settings for all zones, select an option:
 - On an Apple device, select  > **SEND DSP SETTINGS**
 - On an Android device, select  > **Zone** > **SEND DSP SETTINGS**.

Automatic Volume Adjustment Based on Speed

If your stereo is connected to a NMEA 2000® network with a device that provides speed information such as an engine, chartplotter, GPS antenna, water speed sensor, or wind speed sensor, you can set the stereo to adjust the volume automatically based on the selected speed source (*Enabling Automatic Volume Adjustment Based on Speed, page 20*).

For example, if a chartplotter with an internal GPS antenna or a stand-alone GPS antenna is on the same NMEA 2000 network as the stereo and you set the SPEED SOURCE to SPEED OVER GROUND, the volume increases as your speed increases.

NOTE: When the volume increases to adjust for speed, the actual volume output changes, but the volume-level indicator bar and number stays the same.

For more information about connecting the stereo to a NMEA 2000 network, see the installation instructions for your stereo.

Media Player Connection

CAUTION

Always disconnect your media player from the stereo when not in use and do not leave it in your vessel. This helps reduce the risk of theft and damage from extreme temperatures.

Do not remove the media player or use your stereo in a distracting manner while operating the vessel. Check and obey all marine laws in association with use.

The stereo accepts a variety of media players, including smartphones and other mobile devices. You can connect a compatible media player using a Bluetooth wireless connection or a USB connection to the USB port.

Bluetooth Device Playback

You can pair the stereo to up to eight Bluetooth media devices.

You can control the playback using the stereo controls on all Bluetooth devices, and on some devices you can browse the music collection from the menu on the stereo.

On Bluetooth devices that do not support media browsing, you should select the song or playlist on the media device.

The availability of song information such as song title, artist name, track duration, and album art depends on the capability of the media player and music application.

Connecting a Compatible Bluetooth Device

You can play media from a compatible Bluetooth device using the Bluetooth wireless connection.

You can control the music playback with the media app on a Bluetooth device or using the Fusion-Link remote control app ([Fusion-Link Wireless Remote Control App, page 23](#)).

- 1 Select the **BT** source.
- 2 Select  > **BT** > **CONNECTIONS** > **DISCOVERABLE** to make the stereo visible to your compatible Bluetooth device.
- 3 Enable Bluetooth on your compatible Bluetooth device.
- 4 Bring the compatible Bluetooth device within 10 m (33 ft.) of the stereo.
- 5 On your compatible Bluetooth device, search for Bluetooth devices.
- 6 On your compatible Bluetooth device, select the stereo from the list of detected devices.
NOTE: The stereo appears in the Bluetooth device list as the device name (the default name is MS-RA210 unless it was changed in the settings).
- 7 On your compatible Bluetooth device, follow the on-screen instructions to pair and connect to the discovered stereo.

When pairing, your compatible Bluetooth device may ask you to confirm a code on the stereo. The stereo does not display a code, but it does connect correctly when you confirm the message on the Bluetooth device.

- 8 If your compatible Bluetooth device does not immediately connect to the stereo, repeat steps 1 through 7.
NOTE: If another Bluetooth device is already playing music on the stereo, connecting a new device will not interrupt playback. You must select the newly-added device if you want to use it instead ([Selecting a Different Bluetooth Device, page 7](#)).

The DISCOVERABLE setting is disabled automatically after two minutes.

NOTE: On some Bluetooth devices, adjusting the volume on the device affects the volume level on the stereo.

Bluetooth Range Information

The stereo and Bluetooth wireless devices have a range of 10 m (33 ft.). For optimal performance, the Bluetooth wireless device should also have a clear line of sight to the stereo.

Selecting a Different Bluetooth Device

When you have more than one Bluetooth device paired to the stereo, you can select a different device when needed. You can pair the stereo with up to eight Bluetooth devices.

- 1 With the **BT** source selected, select  > **BT** > **CONNECTIONS** > **PAIRED DEVICES**.
- 2 Select a Bluetooth device.

Bluetooth Source Menu and Settings

With the BT source selected, select  > **BT**.

NOTE: The options in this menu vary based on the connected device.

CONNECTIONS > DISCOVERABLE: Allows the stereo to be visible to Bluetooth devices. You can turn off this setting to prevent possible interruption to audio after pairing a Bluetooth device to the stereo.

CONNECTIONS > PAIRED DEVICES: Shows a list of Bluetooth devices paired with the stereo. You can select a device in the list to connect it to the stereo if it is in range.

CONNECTIONS > REMOVE DEVICE: Removes the Bluetooth device from the stereo. To listen to audio from this Bluetooth device again, you must pair the device again.

NOTE: You should also remove the stereo from the list of paired devices on your Bluetooth device to avoid connection issues when pairing the device again.

REPEAT: Sets the repeat mode for the current selection (Apple devices only). You can repeat the current selection by selecting the REPEAT ONE option. You can repeat all items in the selection by selecting the REPEAT ALL option.

SHUFFLE: Shuffles the tracks in the folder, album, or playlist (Apple devices only).

PLAYLIST: Displays the playlists on the device (Apple devices only).

ARTISTS: Displays the artists on the device (Apple devices only).

ALBUMS: Displays the albums on the device (Apple devices only).

GENRES: Displays the genres of music on the device (Apple devices only).

SONGS: Displays the songs on the device (Apple devices only).

Disabling Bluetooth Auto Connection

By default, the stereo automatically reconnects to the last connected Bluetooth device when you turn it on. You can disable this setting.

Select  > **SETTINGS > SOURCE > BT > AUTO CONNECT**.

When the AUTO CONNECT checkbox is clear, the stereo will not attempt to automatically reconnect to a Bluetooth device. When this feature is disabled, you must select a Bluetooth device manually to connect it ([Selecting a Different Bluetooth Device, page 7](#)).

USB Device Playback

You can connect various USB media players, USB flash drives, and smartphones to the stereo. How you access the USB source depends on the type of connected media player or smartphone.

Media Player	Source Selections
Android device	MTP
Apple device	iPOD
USB flash drive	USB
MP3 media player (as a mass-storage device)	USB NOTE: If your MP3 media player does not support mass-storage when connected using USB, you must connect it to the stereo as an auxiliary device (Connecting an Auxiliary Device, page 18).

You can control the playback using the stereo controls on all USB devices, and on some devices you can browse the music collection from the menu on the stereo. On USB devices that do not support media browsing, you should select the song or playlist on the media device.

The availability of song information such as song title, artist name, and track duration depends on the capability of the media player and music application.

USB Device Compatibility

You can use a USB flash drive or the USB cable included with your media player to connect a media player or mobile device to the USB port.

The stereo is compatible with iAP2 Apple devices such as the iPhone® Xs Max, iPhone Xs, iPhone XR, iPhone X, iPhone 8 Plus, iPhone 8, iPhone 7 Plus, iPhone 7, iPhone SE, iPhone 6s Plus, iPhone 6s, iPhone 6 Plus, iPhone 6, iPhone 5s, and iPod touch® (6th generation).

The stereo is compatible with Android devices that support MTP mode.

The stereo is compatible with media players and other USB mass storage devices, including USB flash drives. Music on USB drives must meet these conditions:

- The music files must be formatted as MP3, AAC (.m4a), or FLAC, files.
- If you connect a portable hard drive, you must connect it to an external power source. The USB port on this stereo cannot provide power for a portable hard drive.
- The USB mass storage device must be formatted using one of the following systems:
 - Microsoft®: NTFS, VFAT, FAT¹, MSDOS
 - Apple: HFS, HFSPLUS
 - Linux: EXT2, EXT3, EX4

Connecting a USB Device

You can connect a USB device to the USB port on the stereo.

You cannot connect a USB device to the remote control. You must connect a USB device to the stereo you are controlling with the remote control.

- 1 Locate the USB port on the back of the stereo.
- 2 Connect the USB device to the USB port.

Controlling Music Playback on a USB Flash Drive or Media Player

- 1 Connect a compatible USB flash drive or media player to the stereo.
- 2 Select the **USB** source.
- 3 Select  > **USB**.
- 4 Select the name of the USB device.
- 5 Browse the music files on the device and begin playback.

You can use the stereo controls to select, play, pause, and skip tracks.

TIP: If the USB media player has a screen and controls, you can use the controls on the USB media player to control playback.

Controlling Music Playback on a Connected Android Device

You can connect an Android device to the stereo using a USB cable to play media files stored on the Android device. To play media from an app on the Android device, you should connect the device using Bluetooth technology instead ([Bluetooth Device Playback, page 7](#)).

- 1 Connect a compatible Android device to the stereo using an appropriate USB cable.
- 2 If necessary, enable USB file transfer or MTP on your Android device.
See the documentation available for your Android device for more information.
- 3 Select the **MTP** source on the stereo.
- 4 Select  > **MTP**.
- 5 Browse the music files on the Android device and begin playback.

You can use the stereo controls to select, play, pause, and skip tracks.

¹ FAT includes most types of FAT file systems except exFAT.

Controlling Music Playback on a Connected Apple Device

- 1 Connect a compatible iAP2 Apple device to the stereo using USB.
- 2 Select the **iPOD** source on the stereo.
- 3 Launch a music application on the connected Apple device, and begin playback.

You can use the music application on the Apple device or you can use the stereo controls to browse the music library and to select, play, pause, and skip tracks.

USB Source Settings

With a USB device connected and a USB source selected, select , then select USB, iPOD, or MTP.

NOTE: You can browse the files on the device using this menu. The options in this menu vary based on the connected device.

REPEAT: For a USB or MTP source, select to start playing the tracks in the list from the beginning after the last track has played.

For an iPOD source, select REPEAT ONE to repeat the current track, or select REPEAT ALL to start playing the tracks in the folder, album, or playlist from the beginning after the last track has played.

SHUFFLE: For a USB or MTP source, select to randomly play the tracks in the list.

For an iPOD source, select to randomly play the tracks in the folder, album, or playlist.

Radio

To listen to AM or FM radio, you must have a suitable marine AM/FM antenna properly connected to the stereo and be within range of a broadcasting station. For instructions on connecting an AM/FM antenna, see the stereo installation instructions.

To listen to SiriusXM[®] radio, you must have the appropriate equipment and subscriptions ([SiriusXM Satellite Radio, page 11](#)). For instructions on connecting a SiriusXM Connect Vehicle Tuner, see the stereo installation instructions.

To listen to DAB stations, you must have the appropriate equipment ([DAB Playback, page 17](#)). For instructions on connecting a DAB adapter and antenna, see the installation instructions provided with your adapter and antenna.

Setting the Tuner Region

You must select the region you are in to receive AM and FM stations properly.

If you are connected to a compatible SiriusXM tuner and antenna, and have a subscription (USA only), you must select the region you are in to receive SiriusXM stations properly.

NOTE: SiriusXM service is not available in all regions.

You must select the region you are in to receive DAB stations properly.

NOTE: You must connect a compatible DAB module and antenna (not included), to receive DAB stations.

DAB stations are not available in all regions.

- 1 Select  > **SETTINGS**.
- 2 Select **TUNER REGION**.
- 3 Select the region you are in.

Changing the Radio Station

- 1 Select an applicable source, such as **FM**.
- 2 Select **▶||** repeatedly to move through the tuning modes, and select an option:
 - Select **AUTO** to scan and stop on the next available station.
 - Select **MANUAL** to select a station manually.
 - Select **PRESET** to select a saved station preset.
- 3 Select **◀◀** or **▶▶** to tune to the station.
When in **MANUAL** tuning mode, you can hold **◀◀** or **▶▶** to quickly advance through the stations.

SiriusXM Satellite Radio

Only SiriusXM brings you more of what you love to listen to, all in one place. Get over 140 channels, including commercial-free music plus the best sports, news, talk, comedy and entertainment. Welcome to the world of satellite radio. A SiriusXM Vehicle Tuner and subscription are required. For more information, go to www.siriusxm.com.

Setting the Tuner Region for the SiriusXM Source

You must set the stereo to use the USA tuner region before you can listen to SiriusXM Satellite Radio.

Select **≡** > **SETTINGS** > **TUNER REGION** > **USA**.

Locating the SiriusXM Radio ID

You must have the radio ID of your SiriusXM Connect Tuner before you can activate your SiriusXM subscription. You can locate the SiriusXM Radio ID on the back of the SiriusXM Connect Tuner or its packaging, or by tuning your stereo to channel 0.

With the SiriusXM source selected, select **≡** > **SiriusXM** > **CHANNELS** > **ALL CHANNELS** > **000 RADIO ID**.

The SiriusXM Radio ID does not include the letters I, O, S, or F.

Activating a SiriusXM Subscription

- 1 With the SiriusXM source selected, tune to channel 1.
You should be able to hear the preview channel. If not, check the SiriusXM Connect Tuner and antenna installation and connections, and try again.
- 2 Tune to channel 0 to locate the Radio ID.
- 3 Contact SiriusXM listener care by phone at (866) 635-2349 or go to www.siriusxm.com/activatenow to subscribe in the United States. Contact SiriusXM by phone at (877) 438-9677 or go to www.siriusxm.ca/activatexm to subscribe in Canada.
- 4 Provide the Radio ID.
The activation process usually takes 10 to 15 minutes, but can take up to an hour. For the SiriusXM Connect Tuner to receive the activation message, it must be turned on and receiving the SiriusXM signal.
- 5 If the service is not activated within the hour, go to <http://care.siriusxm.com/refresh> or contact SiriusXM Listener Care by phone at 1-866-635-2349.

Selecting a Category

You can control which categories of channels are available when using the **CATEGORY** tuning method.

- 1 With the SiriusXM source selected, select **≡** > **SiriusXM** > **CATEGORY**.
- 2 Select a category.

Using Replay Mode

You can use Replay Mode to control playback of a SiriusXM broadcast.

NOTE: The device enables Replay Mode automatically when playing saved preset channels.

1 If necessary, hold **▶||** to enable Replay Mode.

A progress bar appears at the bottom of the screen.

2 Select an option:

- Press **▶||** to pause and resume playback.
- Press **◀◀** or **▶▶** to skip backward or forward in increments.

NOTE: If you fast-forward or skip forward to the end of the progress bar, the stereo exits Replay Mode automatically.

- Hold **◀◀** or **▶▶** to rewind or fast-forward the track.
- Hold **▶||** to exit Replay Mode.

Alerts

NOTE: The Artist, Song, and Game Alerts feature is compatible with the SXV300 tuner (sold separately). Other tuners are compatible, but may limit the features. Review the user manual supplied with your SiriusXM tuner to learn about features available with your tuner module.

Adding an Artist or Song Alert

You can set alerts for artists and songs so that when a particular song or a song from a particular artist begins to play on any music channel, you can quickly tune to that channel.

- 1 While a particular song or a song from a particular artist is playing, select **☰** > **SiriusXM** > **ADD ALERT** > **SAVE ARTIST/SONG**.
- 2 Select the song or the artist.

Adding Teams for Game Alerts

You can set alerts for sports teams so that when a game featuring a saved team begins to play on any sports channel, you can quickly tune to that channel.

NOTE: A Game Alert is different than a SportsFlash™ alert. A Game Alert lets you know when a game begins, while a SportsFlash alert lets you know when an exciting play occurs during a game.

- 1 Select **☰** > **SiriusXM** > **ADD ALERT** > **GAME ALERT TEAMS**.
- 2 Select a sports league.
- 3 Select a team to fill the check box and add a Game Alert.
- 4 Repeat steps 2 and 3 for each team you want to add to the list of Game Alerts.

Adding Teams from a Live Game

While listening to a game, you can quickly add a team playing to your list of Game Alert teams.

- 1 While listening to a game on a channel, select **☰** > **SiriusXM** > **ADD ALERT** > **SAVE TEAM**.
A list of teams playing in the current game appears.
- 2 Select the team or teams to add to your list of Game Alert teams.

Viewing Active Alerts

You can review active Artist, Song, and Game Alerts.

- 1 Select **☰** > **SiriusXM** > **ACTIVE ALERTS**.
- 2 Select a category.

Managing Alerts

You can manage your saved alerts to select which ones you want to receive. You can delete saved alerts you do not want.

- 1 Select  > **SiriusXM** > **SXM SETTINGS** > **ALERT MANAGEMENT**.
- 2 Select an option:
 - To enable saved alerts for songs only, artists only, or games only, select **ENABLE BY TYPES**, and select a type.
 - To enable saved alerts for specific artists only, select **ENABLE ARTISTS**, and select the artists.
 - To enable saved alerts for specific songs only, select **ENABLE SONGS**, and select the songs.
 - To enable saved game alerts for specific teams, select **ENABLE TEAMS**, and select the teams.
 - To delete all saved alerts for songs, artists, or teams, select **DELETE BY TYPES**, and select a type.
 - To delete saved alerts for specific artists, select **DELETE ARTISTS**, and select the artists.
 - To delete saved alerts for specific songs, select **DELETE SONGS**, and select the songs.
 - To delete saved alerts for specific teams, select **DELETE TEAMS**, and select the teams.

TuneMix™ Feature

NOTE: The TuneMix feature is compatible with the SXV300 tuner (sold separately). Other tuners are compatible, but may limit the features. Review the user manual supplied with your SiriusXM tuner to learn about features available with your tuner module.

Starting and Stopping a TuneMix Collection

Before you can start playing a TuneMix collection, you must create one ([Creating and Customizing a TuneMix Collection, page 13](#)).

The TuneMix feature enables you to mix your favorite music channels to create a custom listening experience.

- 1 Select  > **SiriusXM** > **TUNEMIX**.
- 2 Select a TuneMix collection.



The stereo begins playing the TuneMix collection.
- 3 To stop playing a TuneMix collection, select  > **CHANNELS**, and select a channel.

The stereo stops playing the TuneMix collection and begins playing the selected channel.

Creating and Customizing a TuneMix Collection

You can create up to 10 unique TuneMix collections on the stereo.

NOTE: A TuneMix collection must include at least two of your favorite SiriusXM music channels.

- 1 Select  > **SiriusXM** > **SXM SETTINGS** > **TUNEMIX SETUP**.
- 2 Select a TuneMix collection.
- 3 Select a channel to fill the check box and add it to the TuneMix collection.
- 4 After you are finished customizing the TuneMix collection, select .
- 5 Repeat steps 2 through 4 for each TuneMix collection you want to customize.

SportsFlash Feature

The SportsFlash feature alerts you to key plays from your favorite teams during a live game. When an exciting play happens, a SportsFlash alert appears, and you can tune to the broadcast and hear the play. When the SportsFlash alert ends, you can choose to return to the previous channel, or remain tuned to the game.

To receive SportsFlash alerts, your subscription package must include play-by-play sports channels for the sports leagues you want to include in the alerts.

You can enable, disable, or delete SportsFlash alerts that you have added ([Managing Alerts, page 13](#)).

NOTE: A SportsFlash is different than a Game Alert. A SportsFlash alert lets you know when an exciting play occurs during a game, while a Game Alert lets you know when a game begins.

NOTE: The SportsFlash feature is compatible with the SXV300 tuner (sold separately). Other tuners are compatible but may limit the features. Review the user manual supplied with your SiriusXM tuner to learn about features available with your tuner module.

Adding Teams to Receive SportsFlash Alerts

- 1 Select  > **SiriusXM** > **SPORTSFLASH** > **TEAM SELECT**.
- 2 Select a sports league.
- 3 Select a team to fill the check box and add a SportsFlash alert.
- 4 Repeat steps 2 and 3 for each team you want to add to the list of SportsFlash alerts.

Changing SportsFlash Team Priority

If more than one team for which you have set up SportsFlash alerts are playing at the same time, you can adjust the team priority to hear SportsFlash alerts from your preferred team first.

- 1 Select  > **SiriusXM** > **SPORTSFLASH** > **TEAM PRIORITIES**.
A list of your selected SportsFlash teams appears, in order of priority.
- 2 Select a team to move it up one priority level in the list.
- 3 Repeat the previous step with each team you want to reorder until the priority list is ordered the way you prefer.

Enabling the TuneStart™ Feature

When you enable the TuneStart feature and tune to a preset channel, the stereo starts the current song from the beginning of the song instead of starting it from the point it is at in the live broadcast.

NOTE: The TuneStart feature is available when tuning to preset channels only. The TuneStart feature is compatible with the SXV300 tuner (sold separately). Other tuners are compatible but may limit the features. Review the user manual supplied with your SiriusXM tuner to learn about features available with your tuner module.

If necessary, select  > **SiriusXM** > **SXM SETTINGS** > **TUNESTART**.

When the TuneStart feature starts a song from the beginning, a progress bar appears and you can control the track using the same controls as Replay Mode ([Using Replay Mode, page 12](#)).

Parental Controls

The parental control feature allows you to limit access to any SiriusXM channels, including those with mature content. When the parental control feature is enabled, you must enter a passcode to tune to the locked channels. You can also change the 4-digit passcode.

Unlocking the Parental Controls

You can unlock the parental controls to access locked channels.

- 1 With the **SiriusXM** source selected, select  > **SiriusXM** > **PARENTAL**.
- 2 Select **UNLOCK**.
- 3 Enter the passcode.

TIP: The default passcode is 0000.

The parental controls remain unlocked until you turn off the vehicle or until you lock them again.

Locking Channels

- 1 With the **SiriusXM** source selected, select  > **SiriusXM** > **PARENTAL**.
- 2 Select the **UNLOCK** check box.
- 3 Enter the passcode.
- 4 Select **LOCK/UNLOCK**.

A list of available channels appears.

- 5 Select one or more channels to lock, and select .
- 6 Clear the **UNLOCK** check box to lock the parental controls.

You cannot access the locked channels while the parental controls are locked. You must unlock the parental controls to tune the locked channels.

Clearing All Locked Channels

- 1 With the **SiriusXM** source selected, select  > **SiriusXM** > **PARENTAL** > **UNLOCK**.
- 2 Enter the passcode.
- 3 Select  > **SiriusXM** > **PARENTAL** > **CLEAR ALL LOCKED**.

Changing the Parental Control Passcode

- 1 With the **SiriusXM** source selected, select  > **SiriusXM** > **PARENTAL** > **UNLOCK**.
- 2 Enter the passcode.
- 3 Select  > **SiriusXM** > **PARENTAL** > **CHANGE PIN**.
- 4 Follow the on-screen instructions.

SiriusXM Troubleshooting

Advisory	Description	Resolutions
Check Antenna	The radio has detected a fault with the SiriusXM antenna. The antenna cable may be disconnected or damaged.	<ul style="list-style-type: none"> Verify the antenna cable is connected to the SiriusXM Connect Vehicle Tuner. Inspect the antenna cable for damage and kinks. Replace the antenna if the cable is damaged. SiriusXM products are available at your local car audio retailer, or at www.shop.siriusxm.com.
Check Tuner	The stereo is having difficulty communicating with the SiriusXM Connect Vehicle Tuner. The tuner may be disconnected or damaged.	Verify the SiriusXM Connect Vehicle Tuner cable is connected securely to the stereo.
No Signal	The SiriusXM Connect Vehicle Tuner is having difficulty receiving the SiriusXM satellite signal.	<ul style="list-style-type: none"> Verify the SiriusXM antenna is outdoors with a clear view of the sky. Verify the SiriusXM antenna is mounted securely. Remove obstructions above or next to the SiriusXM antenna. Inspect the cable antenna for damage and kinks. Replace the antenna if the cable is damaged. SiriusXM products are available at your local car audio retailer or at www.shop.siriusxm.com. Consult the SiriusXM Connect Vehicle Tuner installation instructions for more information on antenna installation.
Subscription Updated	The radio has detected a change in your SiriusXM subscription status.	<ul style="list-style-type: none"> Select any button to clear the message. Go to www.siriusxm.com or call 866-635-2349 with questions about your subscription.
Channel Not Available	The channel you requested is not a valid SiriusXM channel, or the channel that you were listening to is no longer available. You may see this message briefly the first time you connect a new SiriusXM Connect Vehicle Tuner.	Go to www.siriusxm.com for more information about the SiriusXM channel lineup.
Channel Not Subscribed	The channel you requested is not included in your SiriusXM subscription package, or the channel you were listening to is no longer included in your SiriusXM subscription package.	Go to www.siriusxm.com or call 866-635-2349 for more information about your subscription package or to subscribe to the channel.
Channel Locked	The channel you requested is locked by the parental control feature.	Refer to the parental control section in the owner's manual to unlock channels.

Clearing SiriusXM Data

You can clear all entered SiriusXM user information, such as favorite teams and alerts.

Use the **FACTORY RESET** option in the settings menu to reset the stereo (*Update Options*, page 22).

NOTE: The factory reset setting resets all data in the stereo, including AM and FM presets, zone settings, etc. in addition to clearing all SiriusXM user information.

DAB Playback

When you connect a compatible Digital Audio Broadcasting (DAB) module and antenna, such as the MS-DAB100A to the RA210 stereo, you can tune in to and play DAB stations.

DAB broadcasts are not available in all regions. When the stereo is not set to a compatible region, the DAB source is not available.

Setting the Tuner Region

You must select the region you are in to receive DAB stations properly.

- 1 Select  > **SETTINGS**.
- 2 Select **TUNER REGION**.
- 3 Select the region you are in.

Scanning for DAB Stations

Before you can scan for DAB stations, you must connect a compatible DAB module and antenna (not included) to the stereo.



NOTE: Because DAB signals are broadcast in select countries only, you must set the tuner region to a location where DAB signals are broadcast.

- 1 Select the **DAB** source.
- 2 Select  to scan for available DAB stations.

When scanning is complete, the first available station in the first ensemble found begins playing.

NOTE: After the first scan is complete, you can select  again to re-scan for DAB stations. When the re-scan is complete, the system starts playing the first station in the ensemble you were listening to when you started the re-scan.



Changing DAB Stations

- 1 Select the **DAB** source.
- 2 If necessary, select  to scan for local DAB stations.
- 3 Select  or  to change the station.



When you reach the end of the current ensemble, the stereo automatically changes to the first available station in the next ensemble.

TIP: You can hold  or  to change the ensemble.

Selecting a DAB Station from a List

- 1 Select the **DAB** source.
- 2 If necessary, select  to scan for local DAB stations.
- 3 Select  > **DAB** > **BROWSE** > **STATIONS**.
- 4 Select a station from the list.

Selecting a DAB Station from a Category

- 1 Select the **DAB** source.
- 2 If necessary, select  to scan for local DAB stations.
- 3 Select  > **DAB** > **BROWSE** > **CATEGORIES**.
- 4 Select a category from the list.
- 5 Select a station from the list.

Presets

You can save your favorite AM stations and FM stations as presets for easy access.

You can save your favorite SiriusXM channels if the stereo is connected to an optional SiriusXM tuner and antenna.

You can save your favorite DAB stations if the stereo is connected to the proper DAB equipment and set to the correct tuner region. (*DAB Playback, page 17*)

Saving a Station or Channel as a Preset

- 1 With an applicable source selected, tune the stereo to a station or a channel.
- 2 Press and hold **▶II**.

TIP: You can also select **≡**, the name of the source, and **PRESETS > SAVE CURRENT** to save the current station or channel as a preset.

Selecting a Preset from a List

- 1 With an applicable source selected, press and hold the dial.

TIP: You can also select **≡**, the name of the source, and **PRESETS > VIEW PRESETS** to view the list of presets.

- 2 Select a preset.

Removing Presets

- 1 With an applicable source selected, press and hold the dial.

- 2 Select **🗑**.

- 3 Select each preset station or channel you want to remove.

- 4 When you are finished removing presets, select **🗑**.

TIP: You can also select **≡**, the name of the source, and **PRESETS > REMOVE PRESETS** or **REMOVE ALL PRESETS** to remove preset stations or channels.

Connecting an Auxiliary Device

You can connect various auxiliary devices to the stereo. These devices have either RCA connectors, a line output, or a headphone output jack.

- 1 Locate the auxiliary connectors on the wiring harness.
- 2 If necessary, connect an RCA-to-3.5 mm adapter cable to the auxiliary device.
- 3 Connect the auxiliary device to the AUX IN RCA connectors on the wiring harness.
- 4 Select the **Aux** source.

General Settings

Select  > **SETTINGS**.

NOTE: When a check box is filled, the option is on. When the check box is clear, the option is off.

DEVICE NAME: Sets a name for this device.

LANGUAGE: Sets the language on the device.

TUNER REGION: Sets the region used by the FM and AM sources.

This setting is also needed to configure DAB and SiriusXM sources

TELEMUTE: Sets the behavior of the mute function when the device is connected to a hands-free mobile phone using the TELEMUTE wire on the wiring harness . When a call is received, the device can either mute the audio or broadcast the call through the Aux1 input. See your hands-free kit instructions.

NOTE: This setting does not affect a phone connected to the stereo using Bluetooth technology.

POWER OPTIONS: Adjusts power settings, such as the power-save mode (*Power Options, page 22*).

SEARCHING: Enables Fusion Alpha Search Technology (FAST), which allows you to quickly search for tracks by letter or number. You can select a number to enable the FAST menu if your music device contains more than the selected number of items.

ZONE: Enables you to configure the speaker zones (*Speaker Zone Settings, page 19*).

SOURCE: Allows you to enable, disable, and name the sources on the stereo (*Source Settings, page 22*).

UPDATE: Updates the stereo or connected devices (*Update Options, page 22*).

ABOUT: Shows the software version information for the stereo.

Speaker Zone Settings

Disabling the Internal Amplifier

If you do not connect speakers directly to zones 1 and 2, you can disable the internal amplifier to reduce power consumption.

- 1 Select  > **SETTINGS**.
- 2 Select **ZONE**.
- 3 Select **INTERNAL AMP ON** to clear the check box.

Setting the Home Zone

The home zone is the speaker zone that you adjust by default when you turn the dial.

- 1 Select  > **SETTINGS**.
- 2 Select **ZONE > ASSIGN HOME ZONE**.
- 3 Select a zone.

Synchronizing the Source and Zone Volume Levels

You can synchronize the volume levels on one or all zones with some source devices, such as a Bluetooth, AirPlay®, or UPnP source.

- 1 Select  > **SETTINGS**.
- 2 Select **ZONE > PHONE VOLUME SYNC**.
- 3 Select a zone or **ALL**.

When you adjust the volume on the connected source, the volume on the selected zone is also adjusted.

Adjusting the Power-On Volume Limit

By default, when you turn on the stereo, the system automatically reduces the volume to level 12 if it was louder than that when you turned it off. You can adjust this limit if you want to retain a louder volume or limit to a lower volume when you turn on the stereo.

NOTE: This setting affects all zones on the stereo.

- 1 Select  > **SETTINGS**.
- 2 Select **ZONE > POWER ON VOLUME LIMIT**.
- 3 Adjust the volume limit.

Maintaining Individual Zone Volume Levels

If you adjust the volume levels of individual zones so that some zones are louder than others, the individual zone volume settings are all affected when you adjust the volume for ALL zones. By default, if you adjust the volume for ALL to 00, this sets of the volume levels for all zones to 00 and resets all individual zone volume adjustments. You can enable the KEEP VOLUME RATIOS option to retain individual zone volume adjustments when you adjust the volume for ALL to 00.

NOTE: This setting applies to volume adjustments on the stereo or a connected ERX remote control only. If you adjust the volume on the stereo using a connected chartplotter or NRX remote control, the volume levels will still be reset.

TIP: For the best results when enabling this setting, you should set the power-on volume limit to 24 ([Adjusting the Power-On Volume Limit, page 20](#)).

- 1 Select  > **SETTINGS**.
- 2 Select **ZONE > KEEP VOLUME RATIOS**.

Enabling Automatic Volume Adjustment Based on Speed

- 1 Select  > **SETTINGS > ZONE > SPEED VS VOLUME > ENABLED**.
- 2 If needed, update the settings to select the speed source ([Automatic Volume Control Settings, page 20](#)).

Automatic Volume Control Settings

Select  > **SETTINGS > ZONE > SPEED VS VOLUME**.

ENABLED: Enables the automatic volume control feature.

SPEED SOURCE: Sets the source that the stereo uses to determine the speed ([Speed Source Information, page 21](#)).

MAX/MIN SPEED: Sets the expected maximum and minimum speed range for the selected SPEED SOURCE. The MIN setting indicates the speed at which the volume plays at the level you set by turning the dial. The MAX setting indicates the speed at which the volume plays at the highest level set in the VOLUME INCREASE setting.

TIP: You should start by setting these values at the speeds you typically expect from your engine or sensor and adjust them as needed.

VOLUME INCREASE: Sets the total volume increase for each zone when the selected SPEED SOURCE reaches the set maximum speed set in the MAX/MIN SPEED setting. The higher you set this level, the louder the volume will be as you approach the set maximum speed.

NOTE: When the volume increases to adjust for speed, the actual volume output changes but the volume-level indicator bar and number stays the same.

CUSTOM UNITS: Changes the measurement unit used to indicate the vessel or wind speed.

Speed Source Information

Select  > **SETTINGS** > **ZONE** > **SPEED VS VOLUME** > **SPEED SOURCE**.

ENGINE SPEED: Uses the RPM reading provided by a supported NMEA 2000 engine. The volume increases as the engine RPM increases from the set MIN speed to the set MAX speed. If multiple supported engines are connected, the stereo uses the average RPM reading from all engines.

SPEED OVER GROUND: Uses the speed over ground (SOG) reading provided by a supported NMEA 2000 GPS antenna or chartplotter with an internal GPS antenna. The volume increases as the SOG increases from the set MIN speed to the set MAX speed.

SPEED THROUGH WATER: Uses the speed through water (STW) reading provided by a supported NMEA 2000 water-speed sensor. The volume increases as the STW increases from the set MIN speed to the set MAX speed.

WIND SPEED: Uses the wind speed reading provided by a supported NMEA 2000 wind-speed sensor. The volume increases as the wind speed increases from the set MIN speed to the set MAX speed.



Disabling a Zone

You can disable an unused zone and remove it from the audio level pages. When a zone is disabled, you cannot change any of the settings for that zone. You cannot disable zone 1.

- 1 Select  > **SETTINGS**.
- 2 Select **ZONE**.
- 3 Select a zone.
- 4 Select **ZONE ENABLED** to clear the check box.

Setting a Zone Name

You can set a name for a speaker zone to make it easier to identify.

- 1 Select  > **SETTINGS**.
- 2 Select **ZONE**.
- 3 Select a zone.
- 4 Select **ZONE NAME**.
- 5 Use the on-screen keyboard to enter a name, and select .

Linking Zones

You can link zones 1 and 2 to keep the volume levels synchronized. Adjusting the volume of either of the linked zones affects both zones.

- 1 Select  > **SETTINGS**.
- 2 Select **ZONE** > **ZONE 2** > **LINK TO ZONE 1**.

NOTE: After zones 1 and 2 are linked, you cannot adjust the volume of each zone individually.

Adjusting the Subwoofer Filter

You can use the subwoofer filter setting to control the subwoofer cutoff frequency for each zone, which can enhance the blend of the sound produced by the speakers and the subwoofer. Audio signals above the selected frequency are not passed to the subwoofer.

NOTE: If a DSP setting has been applied to the zone using the Fusion-Link app, this setting cannot be changed on the stereo.

- 1 Select  > **SETTINGS**.
- 2 Select **ZONE**.
- 3 Select a zone.
- 4 Select **SUB. FREQ.**.
- 5 Select a frequency.

Adjusting Additional Audio Settings for a Zone

- 1 Select  > **SETTINGS**.
- 2 Select **ZONE**.
- 3 Select a zone.
- 4 Select one or more options:
 - To limit the maximum volume output of this zone, select **VOLUME LIMIT**, and adjust the level.
 - To adjust the right and left speaker balance of this zone, select **BALANCE**, and adjust the balance.
 - To reduce the power output to the external amplifier associated with this zone, select **EXT. AMP GAIN**, and adjust the gain level.
 - To reduce the power output to the internal amplifier associated with this zone, select **INT. AMP GAIN**, and adjust the gain level.

NOTE: This setting is available only for zones associated with an internal amplifier, typically zones 1 and 2.
 - To change the output of this zone from stereo to mono, select **MONO**.

NOTE: The mono setting is useful if a listening position is closer to one speaker than the other and predominantly hear only that channel. The mono setting combines both channels in each speaker in the zone.

Power Options

Select  > **SETTINGS** > **POWER OPTIONS**.

POWER SAVE: Disables the LCD backlight after one minute of inactivity to save battery power.

Source Settings

Select  > **SETTINGS** > **SOURCE**, and select the name of the source you want to configure.

NOTE: This menu contains system-wide source settings. Most sources also have source-specific settings. See the sections of this manual for each source for more information about source-specific settings.

Not all options are available for every source on the stereo.

SOURCE ENABLED: Enables and disables the source on this stereo. You may want to disable sources that will never be used on the stereo so they no longer appear on the source-selection screen.

SOURCE NAME: Changes the name of the source as it appears on this stereo.

Update Options

Select  > **SETTINGS** > **UPDATE**.

NOTICE

Do not turn off the device or disconnect the power during a software update. Turning off the power during a software update may cause the device to become unresponsive.

NOTE:

- You can update the device software using a USB flash drive (*Updating the Software Using a USB Flash Drive, page 24*).
- The device may restart a few times when updating. This is normal.
- You can program only newer versions of software on the device.

STEREO: Updates the stereo using a valid software update file on a connected USB flash drive (*Updating the Software Using a USB Flash Drive, page 24*).

NRX REMOTE: Updates an optional NRX remote connected to the NMEA 2000 port or NMEA 2000 network.

DAB MODULE: Updates an optional DAB module connected to the SIRIUS XM port.

FACTORY RESET: Restores all settings to the factory default values.

Additional Stereo Control Options



Connecting to a Garmin® Watch

For more information about the watch, see the watch manual at garmin.com/manuals.

- 1 Following the instructions in the watch manual, install the Fusion-Link Lite™ app from the Connect IQ™ store onto the watch.
- 2 On the stereo, select the **BT** source.
- 3 Select  > **BT** > **CONNECTIONS** > **DISCOVERABLE**.
The stereo remains discoverable for two minutes.
- 4 Bring the watch within 3 m (10 ft.) of the stereo.
NOTE: Stay 10 m (33 ft.) away from other ANT® devices while pairing.
- 5 Open the Fusion-Link Lite app on the watch.
The first time you open the app on the watch, the watch automatically pairs with and connects to the stereo. If you need to pair to another stereo, in the Fusion-Link Lite app, select **Settings** > **Pair new**.
- 6 Control the audio playback using the Fusion-Link Lite app on the watch.

After the devices are paired, they connect automatically when they are turned on, within range, and the app is open on the watch.

Connecting to an ARX70 Remote Control

- 1 On the stereo, select the **BT** source.
- 2 Select  > **BT** > **CONNECTIONS** > **DISCOVERABLE**.
- 3 Bring the ARX70 remote control within 10 m (33 ft.) of the stereo.
NOTE: Stay 10 m (33 ft.) away from other ANT devices while pairing.
- 4 On the ARX70 remote control, press and hold  until the status LED starts alternating green and red.
The remote control searches for the stereo. When the remote control pairs successfully, the status LED turns on green briefly and then turns off.

If the remote control cannot find the stereo, the status LED turns on red briefly and then turns off.

Fusion-Link Wireless Remote Control App

You can use the Fusion-Link remote control app on your compatible Apple or Android device to adjust the stereo volume, change the source, control playback, select and manage radio presets, and adjust some stereo settings. You can use the app to set up and configure DSP profiles on the stereo.

The app communicates with the stereo using a wireless connection to the mobile device. You must connect your compatible device to the stereo using Bluetooth technology to use the app.

You can connect an Apple device to the stereo using a USB cable to update the stereo software.

For information about the Fusion-Link remote control app for compatible Apple or Android devices, go to the Apple App StoreSM or the Google Play™ store.

FUSION-Link™ Network Technology

FUSION-Link network technology allows you to fully control compatible Fusion entertainment systems on compatible multi-function displays installed at the helm, flybridge, or navigation station of the vessel. This provides integrated entertainment control and a less cluttered console.

The partnered multi-function display becomes the portal on which you can control all audio on the vessel, no matter where on the vessel the connected stereo is installed. The FUSION-Link equipped stereo can be installed out of sight if space is an issue and users need to access the stereo only to replace removable media.

FUSION-Link technology offered on this device can communicate using existing industry-standard NMEA 2000 networks.

NMEA 2000 Remote Control and Display

The stereo can be controlled by compatible Fusion wired remote controls installed in the audio zones throughout the vessel. Operating the entertainment system from the remote control is similar to operating it from the main stereo.

Fusion wired remote controls operate over an existing NMEA 2000 network, so wiring the remote controls directly to the stereo is not necessary. All remote controls connected to the same NMEA 2000 network as the stereo can control the stereo.

The Fusion wired remote control can also serve as an NMEA® display showing NMEA navigation data or vessel performance data from other NMEA devices on an existing NMEA 2000 network. See the instructions provided with your remote control for information on supported NMEA 2000 PGN information.

NMEA 2000 Information

NMEA 2000 is the most popular marine standard for data communication within vessels. It has become the standard for sending navigation and engine management data within vessels. Fusion introduces an industry-first product by incorporating NMEA 2000 functionality in its audio remote control devices. This enables the user to monitor a series of NMEA sentences available over the NMEA 2000 network on a connected remote control.

Appendix

Registering Your Fusion Device

Help us better support you by completing our online registration today.

- Go to garmin.com/account/register/.
- Keep the original sales receipt, or a photocopy, in a safe place.

Software Updates

For best results, you should update the software in all Fusion devices at the time of installation to ensure compatibility.

You can update the software using a USB flash drive. For software updates and instructions on updating the device using the USB flash drive, go to the device product page at support.garmin.com.

Updating the Software Using a USB Flash Drive

You can update the device software using a USB flash drive.

NOTICE

Do not turn off the device or disconnect the power during a software update. Turning off the power during a software update may cause the device to become unresponsive.

NOTE:

- You cannot update the software using a USB flash drive formatted using the NTFS file system. If you encounter problems updating the device, format the USB flash drive using FAT32 and try the update process again.
 - The device may restart a few times while updating the software. This is expected behavior.
 - You can program only newer versions of software on the device.
- 1 Go to the page for your device on support.garmin.com, and download the update file.
 - 2 Extract the contents of the .zip file to the root of your USB storage device.
The contents of the software update are contained in a folder named Garmin.
 - 3 Insert the USB storage device into the USB port of the stereo.
 - 4 Select  > **SETTINGS**.
 - 5 Select **UPDATE > STEREO > YES**.

Troubleshooting

The stereo does not respond to key presses

- Hold  until the stereo turns off, and turn it on again to reset the stereo.
- Disconnect power to the stereo for two minutes to reset the stereo.

The stereo keeps locking up when connected to an Apple device

- Press and hold the power button to reset the stereo.
- Reset the Apple device. Go to www.apple.com for more information.
- Make sure you have the latest version of iTunes® and the latest operating software on your Apple device.

The stereo is not finding my connected Apple device

- Make sure your Apple device supports Interface Accessory Protocol 2 (iAP2). This stereo is not compatible with iAP1 devices.
- Make sure you have the latest version of iTunes and the latest operating software on your Apple device.
- Make sure you have the latest version of the Fusion-Link application on your Apple device.
- Reset the Apple device.
Go to www.apple.com for more information.
- Contact your Fusion dealer or go to support.garmin.com.

My Bluetooth audio is interrupted by short breaks

- Ensure the media player is not covered or obstructed.
Bluetooth technology performs best with line-of-sight operation.
- Bring the media player within 10 m (33 ft.) of the stereo.
- Turn off the **DISCOVERABLE** setting after pairing a Bluetooth device to the stereo.

The stereo does not display all song information from my Bluetooth source

The availability of song information such as song title, artist name, track duration, and album cover artwork depends on the capability of the media player and music application.

Specifications

Weight	350 g (12.4 oz.)
Water rating	IEC 60529 IPX6 and IPX7 (front of stereo only, when properly installed) ¹ IEC 60529 IPX2 (rear of stereo)
Operating temperature range	From 0 to 50°C (from 32 to 122°F)
Storage temperature range	From -20 to 70°C (from -4 to 158°F)
Input voltage	From 10.8 to 16 Vdc
Current (max.)	15 A
Current (muted)	Less than 400 mA
Current (off)	Less than 100 mA
Fuse	15 A mini-blade type
NMEA 2000 LEN @ 9 Vdc	1 (50 mA)
Bluetooth wireless range	Up to 10 m (30 ft.)
ANT wireless range	Up to 3 m (10 ft.)
Wireless frequencies/protocols	Bluetooth 2.4 GHz @ 12 dBm nominal ANT 2.4 GHz @ 7 dBm nominal
Compass-safe distance	15 cm (5.9 in.)

On-board, Class D amplifier

Output music power per channel	4 x 50 W max. 4 Ohm
Total output peak power	200 W max.
Output power per channel	4 x 26 W RMS at 14.4 Vdc input, 4 Ohm, 10% THD ²
Line output level (max.)	5.5 V (peak to peak)
Aux input level (typical)	1 V RMS

Tuner frequencies

Tuner	Europe and Australasia	USA	Japan
FM radio frequency range	87.5 to 108 MHz	87.5 to 107.9 MHz	76 to 95 MHz
FM frequency step	50 kHz	200 kHz	50 kHz
AM radio frequency range	522 to 1620 kHz	530 to 1710 kHz	522 to 1620 kHz
AM frequency step	9 kHz	10 kHz	9 kHz

¹ When properly installed, the front of the stereo withstands incidental exposure to water of up to 1 m for up to 30 min, and is protected against powerful jets of water. For more information, go to www.garmin.com/waterrating.

² The stereo may limit the output power to prevent the amplifier from overheating, and to maintain the audio dynamics.

Stereo Dimension Drawings

Side Dimensions

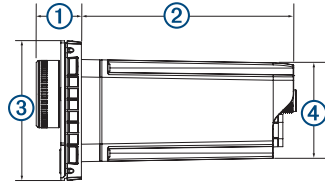

①	22 mm (0.87 in.)
②	104.6 mm (4.12 in.)
③	68 mm (2.68 in.)
④	49.8 mm (1.96 in.)

Top Dimensions

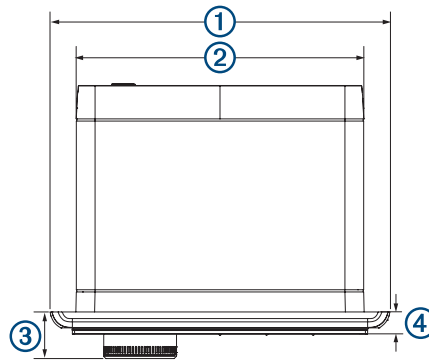

①	157 mm (6.18 in.)
②	130 mm (5.10 in.)
③	22 mm (0.87 in.)
④	10 mm (0.39 in.)

Index

A

alerts **12, 13**
AM **10, 11, 18**
amplifier **19**
Android **9**
Android device **8, 10**
Android devices **9, 23**
ANT devices **23**
Apple device **8, 10, 25**
Apple devices **9, 23**
auxiliary input **5, 18**

B

backlight **4**
bass **5**
Bluetooth devices **6–8, 23**
brightness **4**

D

DAB **10, 17, 18**
device, registration **24**
DSP **5, 6**

F

factory settings **22**
FM **10, 11, 18**
FUSION-Link **23**

G

gain **5**

H

home zone **4, 19**

K

keys **3**

L

language **19**

M

media player **9**

N

NMEA 2000 **24**

P

presets **18**
product registration **24**

R

radio
 AM **10**
 FM **10**
 SiriusXM **11–16**
registering the device **24**
remote control **24**
resetting **16, 19**

S

settings **6, 19, 20, 22**
SiriusXM **10, 18**
 parental controls **14, 15**
 Satellite Radio **11, 12, 14, 16**
software, updates **24**
source **4**
speaker zones **5, 21, 22**
 home **4, 19**
speed **6, 20, 21**
subwoofer **5, 21**

T

tone **5**
treble **5**

U

USB **8–10**
 flash drive **8, 9**
USB devices **6, 9**

V

volume **19, 21**
 adjusting **5, 6, 20**
 settings **20, 21**

W

watch **23**

FUSION SUPPORT

New Zealand

09 369 2900

Australia

1300 736 012

Europe

+44 (0) 370 850 1244

USA

623 580 9000

Pacific

+64 9 369 2900



FUSION[®]

A Garmin Brand

[SUPPORT.GARMIN.COM](https://support.garmin.com)